



270-400 HP | **MF 8700 S**



**FROM MASSEY FERGUSON**



# Contents



## Page 04

New MF 8700 S - The new touch of high horse power & precision



## Page 08

MF 8700 S – Bodyscan the new touch of efficiency

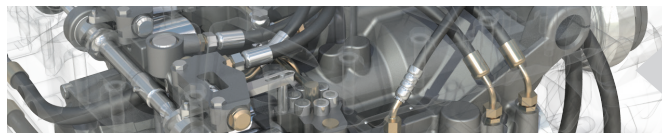

## Page 14

The smoothest power delivery, the ultimate in productivity



## Page 20

The 'Panorama' cab - Little extras makes a big difference



## Page 38

Best in class  
400hp manoeuvrability



## Page 40

Powerful Hydraulic Muscle:



## Page 42

Performing the most demanding operations with precision

- 03 Centre of Engineering and Manufacturing Excellence
- 04 New MF 8700 S - The new touch of high horse power & precision
- 06 The new dimension in farming power
- 08 MF 8700 S – Bodyscan the new touch of efficiency
- 10 MF 8700 S the new touch of big power and efficiency
- 12 Engine power management
- 14 Dyna-VT - The smoothest power delivery, the ultimate in productivity
- 16 Dyna-VT - The tractor transmission without limits
- 18 The new touch of comfort, safety and control
- 20 The 'Panorama' cab - Little extras makes a big difference
- 22 Efficient - advanced equipment for outstanding accuracy
- 24 Exclusive Package - for those who demand more
- 26 The new touch of Precision Farming
- 28 Guidance options to keep you on track for profit
- 30 Agcontrol™
- 31 Taskdoc™
- 32 AgCommand® puts your finger on the pulse at all time
- 34 The new touch of pulling and traction capacities
- 36 Large footprint for maximum traction with new  
Michelin tyre AXIOBIB2 High Traction tyre option
- 38 Best in class 400hp manoeuvrability
- 40 Powerful Hydraulic Muscle
- 42 Performing the most demanding operations with precision
- 44 The new touch of quality and customer's piece of mind
- 46 Servicing made easy
- 47 MF Services - to increase our customers' profit and efficiency
- 48 No hidden costs: All-Inclusive service from Massey Ferguson
- 50 Standard and optional equipment
- 52 Specifications



Massey Ferguson Tractor Manufacturing Facility at Beauvais,  
France wins French Factory of the Year Award 2016  
"L'Usine Nouvelle"



# Beauvais, France | Centre of Engineering and Manufacturing Excellence

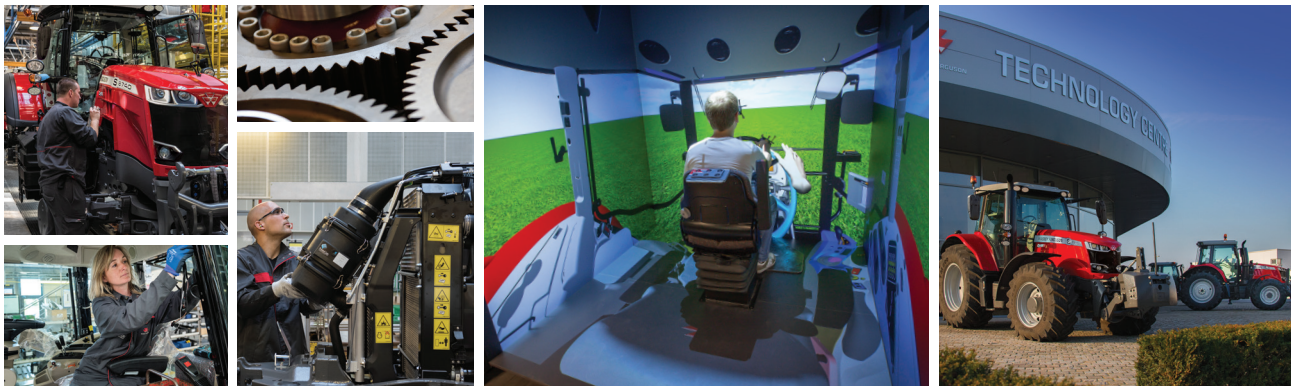

Anyone who buys a Massey Ferguson tractor today will expect it to fulfill the latest operational and environmental standards. They will expect it to combine the very best of today's technologies with comfort, simplicity, reliability, quality and best farming experience.

The MF 8700 S series is designed and built at AGCO's manufacturing facility at Beauvais, France, winner of France's prestigious Factory of the Year 2016 award, organised by L'Usine Nouvelle, the leading industrial magazine in France.

The Beauvais site designs and manufactures Massey Ferguson tractors from 75-400hp and is France's largest producer and exporter of farm machinery. The site is also ISO 9001 certified.

The €300m investment made over the last five years in the Beauvais tractor plant, home of Massey Ferguson's high horsepower range of tractors, has been carried out with a singular aim: to ensure Massey Ferguson tractors are built to standards of quality, reliability and productivity that guarantee peace of mind for the owners and operators who depend on them.

This is at the heart of everything we do at Beauvais. Our engineers have farming in their blood and visionary power. They are eager to develop new solutions to the complex challenges of today's and tomorrow's farming, such as fuel-saving Selective Catalytic Reduction (SCR), which we were first to bring to the market. The result is tractors which help you farm more efficiently and more profitably.



**2,500+** employees

The plants combined cover **30+ hectares**  
Boasts impressive credentials

The Beauvais plants are at the forefront of Massey Ferguson's **SUCCESS** responsible for the design & production of the latest

**300 million Euros** invested for Beauvais plants during the **Last 5 years**

Daily production up to **100** tractors

**85%** of the production shipped to countries globally **70+**

**925,000+** Massey Ferguson tractors have been built since **Beauvais 1** site opened for business **22<sup>nd</sup> November 1960**

Tractor power range **75-400 hp**

MF 4700  
MF 5700  
MF 6700 S  
MF 7700 S  
MF 8700 S





**MF 8700 S**



# MF 8700 S

## The new touch of high horse power & precision farming

The MF 8700 S was for many years the Champion of the Field and represented the pinnacle of Massey Ferguson's engineering achievements in terms of quality, reliability, performance and fuel efficiency in the high horse power segment. It was not an easy task to design its successor, but that is precisely why it is so very exciting.

With the new MF 8700 S we are setting the bar a touch higher. Among the great innovations are still "high-efficiency" SCR AGCO Power engines providing up to 400 hp for impressive traction capacities yet with industry leading power-to-weight-ratio and lighter footprint on the ground, more safety and comfort without compromise for the operator and a comprehensive line-up of Precision Farming tools operated through the 9" capacitive touch screen of the brand new Datatronic 5 to boost even further any farmer's productivity.

**The New MF 8700 S Series is aimed at customers looking for a New touch of high horse power and a precision farming tractor with inspired design and optimised efficiency.**

The face of the New MF 8700 S captures and holds your attention. At its centre is the iconic MF triple triangle logo, around which flows the powerful shape of the MF bar lights iconic to the MF S effect : the whole design exudes amazing power, engineered quality and distinctive style.

The New MF 8700 S with its powerful new styling is designed to captivate you from the start. The NEW MF light bar and iconic MF triple triangle logo is at the heart of the 'S' effect distinctive styling, the full embodiment of MF's power, design and engineering quality.

400hp





Farming practices in today's climate have many obstacles which farmers and contractors have to face. With the world's population rising, a greater demand for food and land with changeable and volatile weather conditions, you need machinery you can rely on.

We understand those new challenges and our engineers are at the forefront of tractor design and so our new range of flagship tractors has been designed and built by the people who truly understand the nature of your business. Through insight and innovation we built the MF 8700 S to meet the needs of modern farming so you can look to the future with confidence.



## The new dimension in farming power

### Highlights

- **New generation AGCO Power engines** provide levels of torque and horse-power unsurpassed in conventional tractor design, from the minimum of fuel. Coupled with the ultimate in transmission technology – the blend of efficiency, economy and ease of use that marks out Dyna-VT as the finest CVT in the business – these are tractors built to handle the heaviest loads and the hardest tasks.
- **A Best-in-Class operator environment** is nothing more than you would expect for a tractor of this type – and from Massey Ferguson in particular. Putting you in control of this power is a first class cabin offering state-of-the-art comfort and controls for full operating precision hour after hour.
- Massey Ferguson has long been a **leader in providing solutions to help farmers keep operating costs to a minimum**, and the MF 8700 S tractors continue that legacy, incorporating the latest Datatronic 5 and Precision Farming package to ensure operators and owners are kept informed and their machines are working at their optimum.
- All this is backed up by the **best customer service in the business**, designed to ensure that your machines are always operating at their optimum. Massey Ferguson dealers provide out-of-season servicing that fully prepares you for the year ahead, while in the event of a breakdown they will ensure your machine is up and running as soon as possible.

Already setting the benchmarks for the high-horsepower tractor sector, the MF 8700 S models feature key components that have been optimised and enhanced over those of their predecessors to bring a new level of performance to the industry.

	MF 8727 S	MF 8730 S	MF 8732 S	MF 8735 S	MF 8737 S	MF 8740 S
<b>Engine</b>	AGCO Power Stage IV (T4 Final) 8.4 litre, six cylinder					
<b>Transmission</b>	Dyna-VT					
<b>Max power @ 1900 rpm (hp)</b>	270	295	320	350	370	400
<b>Average minimum weight with no ballast (kg)</b>	10,800	10,800	10,800	10,800	10,800	10,800
<b>Minimum power to weight ratio (hp/Kg)</b>	40	35	33	30	29	27

## MF 8700 S – Bodyscan the new touch of efficiency



Across the board, we have injected new thinking into the design and features of the MF 8700 S, to improve power, comfort, usability, efficiency and reliability.



All new features on the new MF 8700 S



### Ultimate comfort and safety for more productive working day

- Panorama Cab with plenty of room available, quietness and 360° visibility.
- Ergonomic and easy to use controls.
- Available with 2 specifications packages to meet your needs.
- New working light package with 18 LED lights extends the working day into night.
- New air braking systems for the tractor and trailers as standard.

### Ability to work faster with most demanding implements

- Superb rear linkage with extreme 12,000 kg lift capacity.
- Up to 6 spool valves on the rear, and 2 in the front.
- Power beyond installation for the more complex implements.

### More power efficiency brings more traction

- Up to 400 hp - The most powerful tractors ever made by Massey Ferguson, designed for the ultimate in output, with low running costs.
- CYCLAIR system designed to match the prodigious power output produced by industry leading 8.4 litre AGCO Power engines.
- The highest 400 hp traction capacity at lightest footprint effect - MF 8740 S, the standard wheel tractor with lowest power to weight ratio: 26.7 kg/hp.

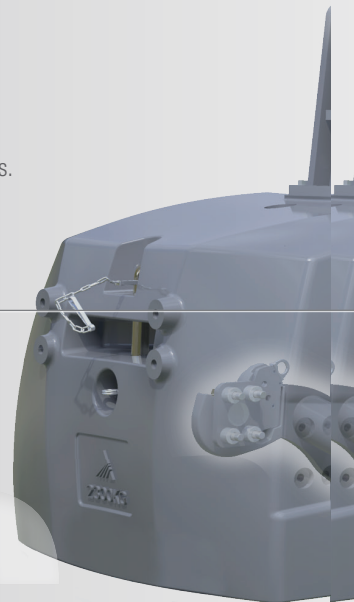

# MF 8700 S





#### **New Datatronic 5 terminal provides the latest user friendly Precision Farming Package**

- Datatronic 5, 9" touch screen terminal created to provide a more intuitive and precise farming experience.
- New Auto-Guide™ solutions provide economy by reducing overlaps.
- AgControl™ allows you to adjust the application rate on the go, whilst automatically minimising overlap, skips and wasted product.
- TaskDoc™ creates and sends securely detailed records of jobs between field and office.
- AgCommand® telemetry for fleet performance and usage management.

#### **Efficient drive-lines bring higher productivity**

- Dyna-VT transmission with Engine Power Management to deliver more power when it is needed most.
- Perfect engine/transmission combination provide maximum outputs.

#### **Perfect tyre choice with more maximum traction and soil preservation**

2.15 metre rear wheel diameter for better traction, reduced soil compaction giving the maximized performance to the ground.

Michelin AxioBib 2 tyres option puts more lugs in contact with the soil, creating 'mini tracks' that lengthen the footprint by 26%, distribute the weight more effectively and improve traction by up to 28%.

## Selective Catalytic Reduction (SCR)

### Selective Catalytic Reduction (SCR) process with the Diesel Oxidation Catalyser (DOC)

- 01 The exhaust gases leave the turbocharger and enter the DOC cylinder.
- 02 The exhaust gases go through the Diesel Oxidation Catalyst (yellow). Carbon Monoxide (CO), Gaseous Hydrocarbons (HC) and Particulate Matter (PM) are neutralised here. Nitrogen oxides are prepared to react with the urea.
- 03 Carefully controlled injection of AdBlue® occurs.
- 04 The gases that have mixed with the AdBlue® leave the DOC cylinder to reach the exhaust pipe which contains the catalyst.
- 05 As the gases pass through the catalyst, the NO<sup>x</sup> is converted into harmless nitrogen and water.
- 06 Clean air and water vapour leave the exhaust pipe.



- AGCO POWER 6 cylinder 8.4 l engines generate power from 270 to 405 hp.
- **Maintenance free**, 3rd generation SCR Technology and all components designed for maximum lifetime and minimum time for service or maintenance, saving your money and maximizing uptime for your tractor.
- **Maintenance free valve** clearance thanks to hydraulic tappet which self adjusts the valve clearance. This reduces the maintenance cost of the tractor by a lot.
- **External EGR** for improved fuel economy and AdBlue® consumption.
- Twin Turbocharger with electronic waste gate installation for **higher power** capacities and **best engine response** at all engine revs.



# MF 8700 S

## the new touch of big power and efficiency

- Automatic low idle system cuts engine revs to **save fuel** when idling while improving noise level in the cab for better operator comfort.
- Optimised high pressure common rail fuel injection limits the emissions of Particulate Matter (PM) and means there is no need to fit a Diesel Particulate Filter to meet the latest T4 final legislation requirements. All Power is available at any time so that the tractor keeps farming, sustaining your business as well as operator's piece of mind and comfort as there is no increased engine noise during forced regeneration at a standstill.
- Invisible technology : All after treatment components located neatly under the bonnet so there is no impact on maintenance/visibility/ground clearance/fuel tank capacity/access/design.
- Efficient and smartly designed cooling package with Cyclair system and new air filter installation means the tractor's engine breathes only clean fresh air which guarantees **longer durability**.

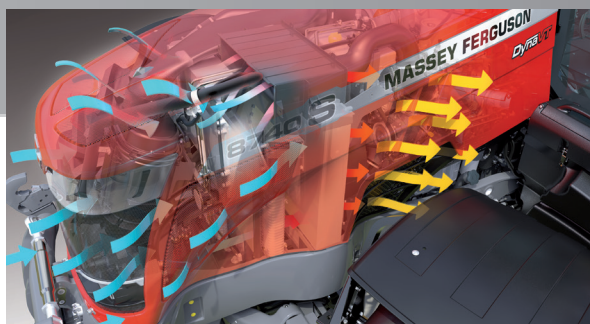

Some people say that looking into the future is a futile business. For Massey Ferguson and our Engineering department, it has always offered an exciting challenge. But that's not all. Our engineers are not content with looking ahead. They have always wanted to influence the future in order to offer highly efficient and powerful engines while minimising fuel consumption which can have a significant effect on a business's bottom line as well as helping to meet the industry's environmental commitments.

Back in 2008, Massey Ferguson, together with AGCO Power, has pioneered SCR Technology as the most straightforward, maintenance free solution to comply with the toughest emissions legislation without compromising on power and productivity. This is now the industry standard but we are still leading the way with 50000 equipped tractors globally ! – The only impact on your business is a positive one – on your fuel bills.

The MF 8700 S Series is a prime example of our combined efforts to refine the efficiency of common rail fuel technology and meet the specific needs of tractor owners in this high horse power segment. From our developments has come the highest horsepower 6 cylinder tractor in the Massey Ferguson Range, offering up to 405 hp courtesy of a fuelling system which calculates precisely the fuel required by the engine at any given moment, responding to the load placed upon it by transport, field, PTO or hydraulic applications. The result: optimum combustion and a cleaner, more powerful, more economical and more reliable engine that produces high levels of torque at low rpm. A 'no compromise' combination.

**The only impact on your business is a positive one – on your fuel bills.**

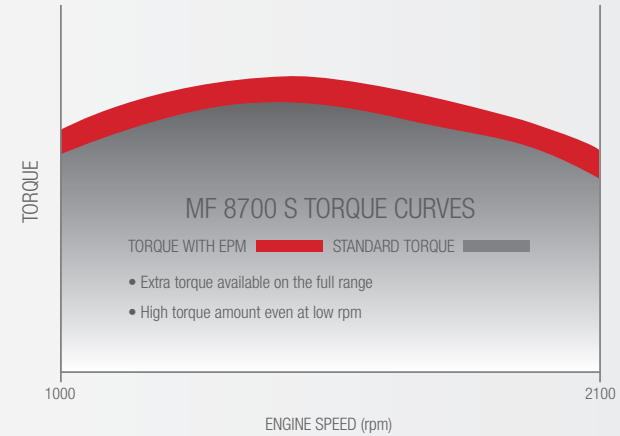
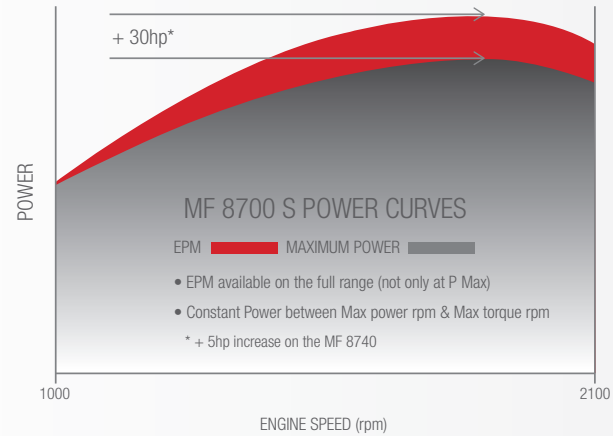

## Engine Power Management

### More muscle when you need it most

Imagine a tractor that responds automatically to the load imposed on it, and adjusts fuelling accordingly to give you extra power when you need it most. MF 8700 S tractors benefit from Engine Power Management, providing a power boost designed to tackle tough transport and PTO work. Advanced electronic engine and transmission management make more power automatically available under load or at speed.

EPM works by way of transmission electronics which monitor the load and operating conditions within the transmission, PTO and hydraulics according to forward speed, transmission load

and PTO activation. This information is then communicated to the electronic engine management system, which then regulates accordingly the quantity and timing of fuel required.

EPM makes up to an additional 30hp\* available. On transport application extra power engages from 15 km/h and become fully available at 22km/h and above.

On PTO or Hydraulic work, extra power automatically becomes available above 0,1 km/h.





Highlights

- EPM available on the whole Power range, not only at P Max.
- High level of constant power between Max Power and Max Torque rpm.
- Torque increase with active EPM on the whole range.
- Stable low fuel consumption between Max. Power and Max Torque.

80  
100  
120  
140  
160  
180  
200  
220  
240  
260  
280  
300  
320  
340  
360  
380  
400  
420  
440  
460  
480  
500  
520  
540  
560  
580  
600  
620  
640  
660  
680  
700  
720  
740  
760  
780  
800  
820  
840  
860  
880  
900  
920  
940  
960  
980  
1000



# MF870S

With the continuously-variable Dyna-VT transmission, we have developed a system of power transfer that surpasses all others for ease of use and efficiency. We have taken a proven, refined transmission and made it even better, ensuring it delivers seamless strength hour after hour. It's intuitive to the operator, the easiest of transmissions to understand and get the most from, and new operators will quickly settle into feeling at one with the tractor.

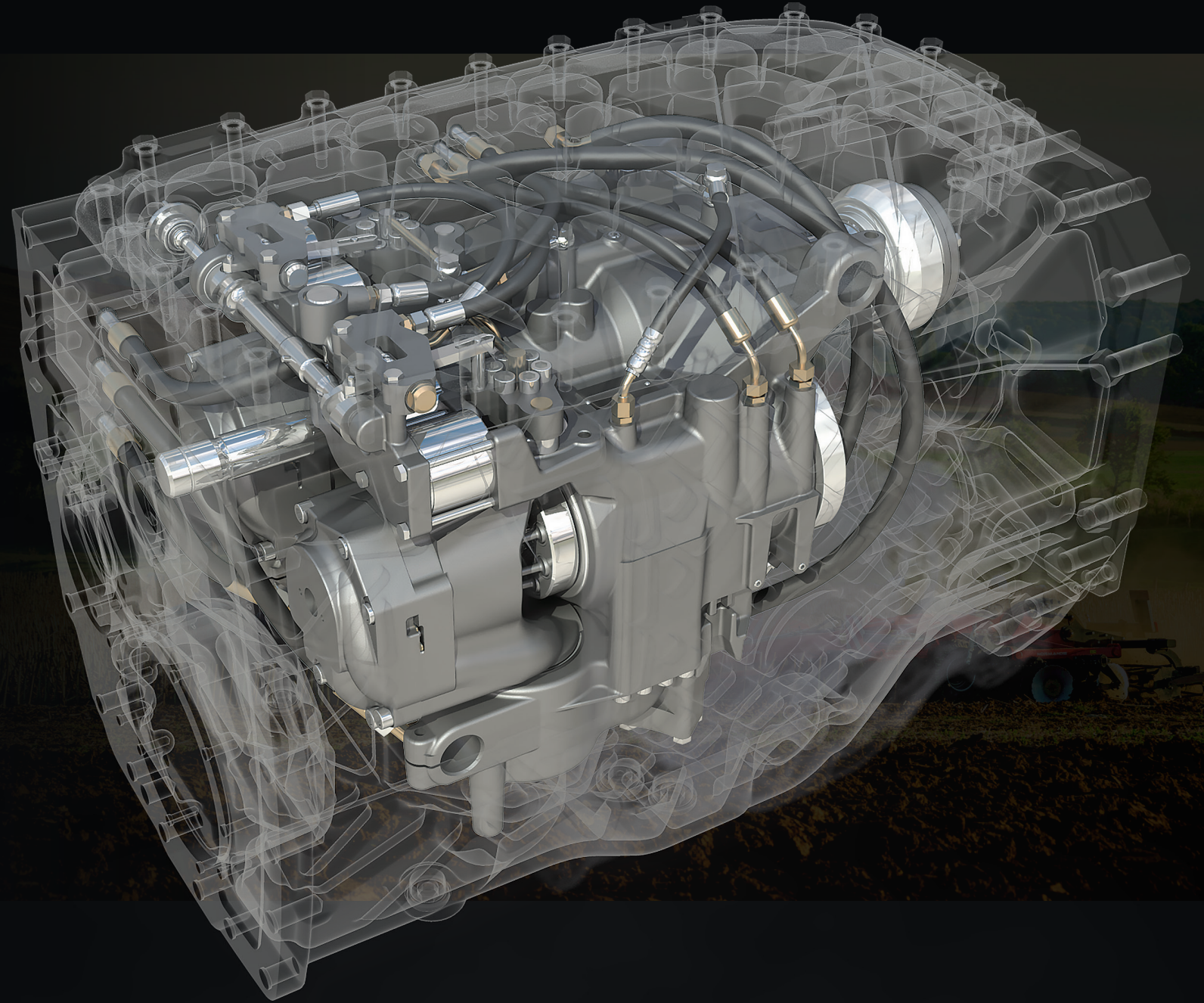



# DynaVT

## The smoothest power delivery, the ultimate in productivity

Dynamic performance whatever the application. Massey Ferguson's Dyna-VT transmission provides enhanced productivity in stepless precision.

Once you have selected the mode in which you wish to drive the tractor – via the foot pedal, with the armrest lever or even with the Power Control lever – you can then focus on the work. Forward and reverse speeds and rate of acceleration can be pre-set and are maintained automatically, and stored in the tractor memory after shut-down for later use, making any operation requiring regular shuttling far less tiring.

**Stepless precision** Dyna-VT offers stepless travel from 0.03 to 40 or 50 km/h\* at any engine speed, operated via two speed ranges. This means it is always possible to achieve the correct operating speed for the conditions and for the implement being used, and it is always possible to achieve the optimum engine speed to maximise work rate and minimise fuel consumption. Engine speed and forward speed are independent of each other, and forward speed can be instantaneously increased or decreased under full load to maximise output and maximise work quality.

Depending on the tractor type specified, Dyna-VT can be operated via either a T-bar controller or the Multipad joystick on the right-hand armrest. Speed variation is also possible through the steering column-mounted PowerShuttle lever.



### Multipad Joystick

The Command Control armrest, and the Multipad joystick - standard on MF 8700 S Exclusive tractors - are part of the package that makes these tractors, despite their power, so easy to control with precision. A multitude of functions can be controlled in the palm of your hand.



### Cruise Control and Supervisor

MF 8700 S tractors are fitted with an engine speed 'Supervisor' which automatically reduces forward speed to maintain full engine power by maintaining engine speed, whatever the job in hand. In conjunction with the ability to store two speed settings, this means the tractor is always working at its optimum.



### Simple, multi-function Power Control

The Power Control lever provides convenient three-in-one, straightforward operation. Operators can shuttle between forward/reverse, select neutral, leaving the right hand free to operate the rear linkage or implement hydraulics.

\*depending on market legislation.



## DynaVT

### The tractor transmission without limits

#### Dyna-VT Highlights:

- 0.03 to 40 km/h or 50 km/h\*.
- 40 km/h super Eco or 50 km/h\* Eco.
- The choice of two speed ranges optimises torque for different applications.
- Lever, pedal or automatic control.
- C1/C2 cruise speeds.
- 'Supervisor' maximises the output under varying loads.
- Dynamic Tractor Management (DTM) maintains the set travel speed by automatically adjusting the power (engine speed) according to load.
- Active Stop.
- Turbo clutch on/off.
- Shuttle aggressiveness adjustment.
- Pedal aggressiveness adjustment.
- Switch between cruise speeds (C1 and C2).
- Brake pedal to neutral feature.

\*Depending on market legislation.



# MF 8700 S

The original Dyna-VT transmission is a true testament to precision engineering; guaranteed productivity, complete operator comfort and optimum fuel efficiency at all times. Further, consistent enhancements such as Dynamic Tractor Management (DTM) make it the most intuitive transmission on the market.

## Stepless precision

Dyna-VT is amazingly simple to operate and works extremely well in differing conditions. There's no shifting of gears, no jolts and no breaks in traction or power. The unique Power Control lever makes forward/reverse shuttling and speed change convenient and hassle-free.

## Dynamic Tractor management

When activated, Dynamic Tractor Management (DTM) works in conjunction with the Dyna-VT transmission, in either level or pedal mode, to automatically control engine speed according to the load on the tractor, maintaining the required forward speed whilst keeping rpm to the minimum necessary. It works from 1000-2100 rpm, with the operator able to set both a lower and an upper limit within the range. DTM can be activated with triggers such as PTO, Linkage or hydraulic activation. The result is smoother driving and excellent fuel efficiency.

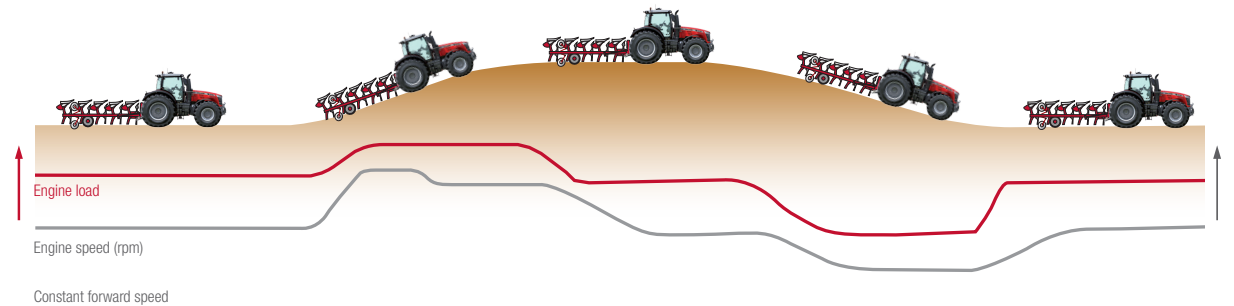

Dynamic Tractor Management (DTM): As the load (red line) varies according to the conditions, the Dyna-VT will automatically adjust the engine speed (grey line) to maintain the forward speed whilst minimising fuel consumption and noise levels.

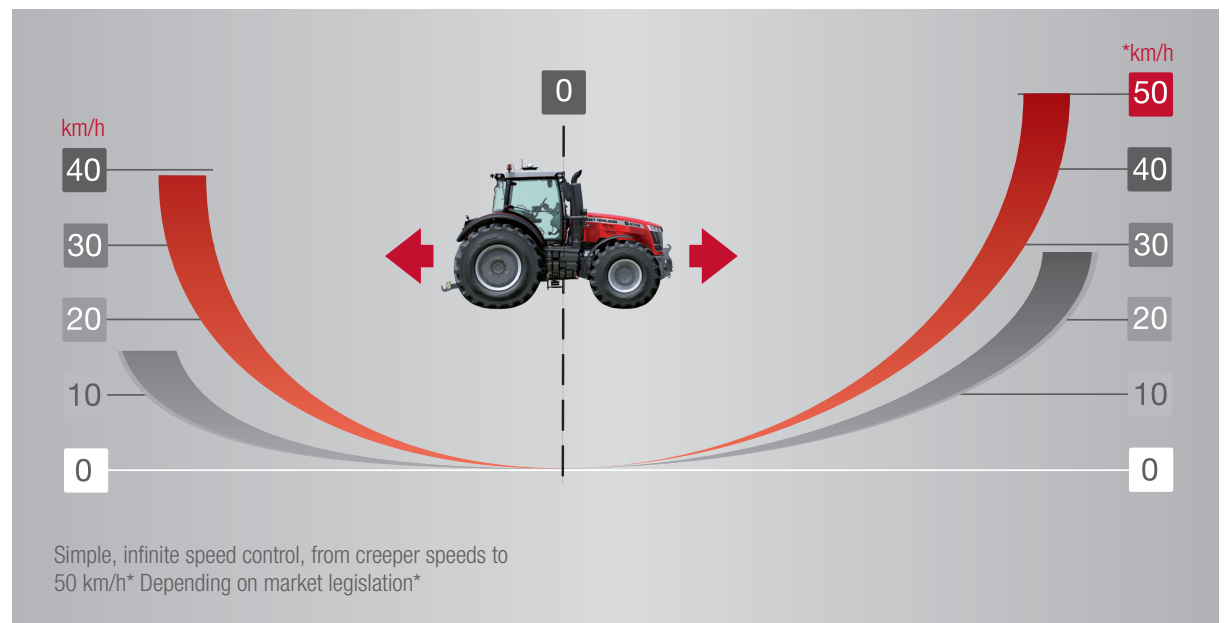

## The new touch of comfort, safety and control

From the origins of modern tractor design, the Massey Ferguson cab has been renowned for excellence, and the MF 8700 S moves that legacy a step forward. It's something we work hard for, so you can sit and reap the benefits when days go on and on, in a very productive environment that blends comfort, quietness, ease of use and quality.

**Because we know that a more productive operator is an operator who creates profit for his business.**

### And there's more in it for you!

The better equipped a tractor is for the job in hand, the easier and more efficiently the job can get done. This is another area where the MF 8700 S really stands out of the crowd: as well as an extensive standard equipment package, it comes with a choice of different cab environments offering a wide range of equipment, giving you all the options that you need.

**You can make your new MF 8700 S as individual as your farm.**



### Efficient or Exclusive – the freedom to choose your own working environment

The MF 8700 S range is available in two specification levels: Efficient and Exclusive, for a choice of premium or super-premium environments and specifications. Both are designed around a spacious frame and logical, carefully thought-out controls. Everything is to hand, with key controls all on the operator's right, and those used most often grouped on the armrest. Compromise isn't necessary – our aim is simply to help you make a personal choice to match your business requirements and objectives.

### Best-in-class design

The four-pillar cab frame design makes for superb 360° all-round vision to the sides and out to the extremities of wide implements, while the cab suspension ensures the operator is always on the level. The level of damping can be set in from the cab, to meet the driver's preference. Paired with a premium-class air-suspended operator's seat, the result is one of the most comfortable rides around.

### Cab suspension brings extra comfort

The NEW active mechanical system uses silent block bushes and spring-assisted shock absorbers to give with the automatic mode optimum damping forces for all driving situations and the reduction of heave/pitch and roll movement.

Active mechanical cab suspension is adjustable, allowing the operator to set the firmness of ride. Adjustment means the operator can control the ride feel according to differing terrain and speed.

### Intuitive ergonomics

Accessed via broad steps and a single, wide, full-glass door, there's plenty of space in the cab for the driver, a passenger and anything required for a long day's work. Once the door is closed and the engine started, you'll notice just how quiet this cab is. Almost everything you need to control the tractor's key functions is grouped on the right-hand armrest, arranged so that operation is almost immediately intuitive.





FROM MASSEY FERGUSON



### New Dashboard with SIS – Setup and Information Screen

A completely new, slim dashboard design provides for quick, clear and easy analysis of operating data, presented on 70 mm x 52 mm colour screen for the SIS. Not only is the new screen 50% larger than before, but it has a resolution ten times better and large graphics that make information easy to read in all light levels.



### Intuitive controls

On the right hand side pillar, a new control layout follows the familiar Massey Ferguson style, incorporating modules to operate the lights, PTO speed selection and rear linkage settings.



**New double angle wing mirrors** provide a great view behind as well as filling in the 'blind spot' lower down to the sides for enhanced safety.



## The 'Panorama' cab





## Little extras makes a big difference

Best-in-class features in the 'Panorama' cab make it the best workplace ever from Massey Ferguson offering the highest levels of comfort, quietness, visibility, space, access and technology. Designed by Massey Ferguson, this spacious, four-post cab ensures operators work in superb comfort with exceptional visibility and control.

With its Generation 3, the MF 8700 S is not standing on its laurels offering more safety and convenience without compromise to the operator. Massey Ferguson consider that operator's safety can't be an option and introduced a new standard series of equipment to drastically reduce the risk of accidents.



**LED light package turns night into day, increasing visibility and safety thanks to its outstanding brightness capacity.**

But the MF 8700 S cab is also available with numerous comfort and convenience features such as automatic beacon activation on the road, comfort light delay at the end of the day with automatic work lights extinction, and illuminated steps.



**Mobile phone and Tablet holders** available as accessories. Extra plug sockets for mobile phones or laptop are available.

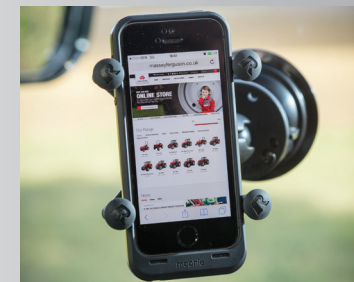

Massey Ferguson has added new details to improve operator safety and comfort, such as integrated folding steps on the right-hand side, and new handrails in various locations to provide safer, easier access to the exterior of the tractor.



**Improved safety on the road.** All MF 8700 S Series are equipped with air braking systems for the trailers as standard, including the option of ABS signal for trailer compliance for ultimate security. For added safety a new linked pedal sensor also meets new requirements for those travelling faster than 40km/hr.



# Efficient Package:

## advanced equipment for outstanding accuracy



Efficient is the entry specification package for the MF 8700 S series but you will notice that it is anything but basic. Dedicated to delivering increased productivity thanks to key features, the Efficient specification will enable the operator to work really fast, to a higher standard, with more accuracy together with high levels of comfort, ergonomics and reliability. It provides all the key elements with a blend of simplicity and ease of use, with all key functions ergonomically grouped in the Control Command Centre armrest.

Standard Efficient features includes:

- Command Control Armrest with « T » lever.
- Datatronic 5, 9" touch screen terminal.
- Power Control Shuttle lever.
- Automatic Air Suspended Swivel Seat.
- "QuadLink" suspended front axle.
- Standard air conditioning.
- 4 electronic spool valve with joystick and fingertip control.
- Radar & slip control.

Efficient specification options:

- OptiRide Plus semi-active cab suspension.
- Super Deluxe Air Suspended Seat.
- Automatic air conditioning.
- Integrated front linkage and front PTO.
- SpeedSteer.
- Auto-Guide™ with Go mode.
- AgCommand® Telemetry system.
- Mirrors with electric de-icing and adjustment.
- 1000 Eco PTO.
- Command Control Armrest with MultiPad lever.





# MF 8700 S



Datatronic 5, 9" touch screen terminal

Joystick spool valve control with assignment switches function

Front hydraulic controls assignment  
Hydraulic activation

Linkage depth control

Fingertip spool valve controls

Transmission control lever

Engine speed memo A & B

Road / field transmission mode

C1 / C2 cruise speed controls

Rear linkage controls

Hand throttle

Fingertip spool valve control

PTO engagement

Lever or pedal mode selection

C1 / C2 cruise speed setting

Dynamic Transmission Management engagement

# Exclusive Package:

## for those who demand more



You'll always find the usual necessities within our cabs but we always strive to push operator comfort and control to the next level. That's why the Exclusive package comes with dramatic new features that will help to improve further your working day.

The Exclusive MF 8700 S Package is dedicated to the more intense, large scale operator looking for more advanced features that will ensure cost effective benefits for their business.

#### Standard Exclusive features includes:

- Command Control Armrest with MultiPad lever.
- Power Control Shuttle.
- "QuadLink" suspended front axle.
- Automatic air conditioning.
- OptiRide Plus semi-active cab suspension.
- Super Deluxe Air Suspended Seat.
- Mirrors with electric de-icing and adjustment.
- DataTronic 5, 9" touch screen terminal.
- Radar & slip control.
- Integrated front linkage.
- SpeedSteer.
- Auto-Guide™ with Go mode.
- AgCommand® Telemetry system.
- 4 electronic spool valve with joystick and fingertip control.

#### Exclusive specification options:

- 2 additional rear remote valves.
- Integrated front PTO.
- 2 sets of hydraulic front couplers and free hydraulic return.
- 1000 Eco PTO.





**Datatronic 5**  
The 9" Datatronic touch screen terminal is sited within easy reach and sight of the driver, and is fully adjustable according to operator preference to allow optimum viewing of all tractor functions.

Multipad joystick  
Selectable spool valve control  
C1 / C2 cruise speed controls  
PTO engagement  
Engine speed memo A  
Forward/reverse shuttle control  
Headland management sequence engagement

Road/field transmission mode  
Joystick ISOBUS engagement  
Rear linkage controls  
Hand throttle

Headland management sequence engagement

Engine speed memo A & B

Joystick spool valve control with assignment switches function

Front hydraulic controls assignment

Hydraulic

Linkage depth control

Fingertip spool valve control

PTO engagement

Lever or pedal mode selection

C1 / C2 cruise speed setting

Dynamic Transmission Management engagement



# The new touch of Precision Farming

Powered by Fuse™ Technologies



**1**  
Full tractor functions management and optimisation features such as transmission, engine and hydraulics.

Moreover there is the remarkable Dual Control system providing excellent control of semi-mounted ploughs by automating the furrow entry and exit. At the same time the system adjusts the plough's depth wheel in relation to the rear linkage. The same system is also used to control implements on the front linkage, automating depth settings and the entire operation, in synchronisation with the rear linkage.



**2**  
Video Mode – Pictures from an on-board camera can be displayed on the console screen, allowing operators to monitor complex implements or simply improve safety and efficiency when reversing.



**3**  
Headland management settings – The Datatronic, 5th Generation 9" touch screen terminal comes as standard with the most intuitive, straightforward and easy to use automatic headland management system available in the market today and developed exclusively by Massey Ferguson. It is designed to save you significant time at headlands, allowing you to concentrate on the operation in hand so that you can maximise outputs with ease.

## Datatronic 5

First introduced in 1986, the Datatronic is now in its 5th Generation, redesigned in order to create a more intuitive Precision Farming experience, providing a system that delivers a straightforward and easy to use experience, improving efficiency, productivity and profitability.





The New Datatronic 5 features a larger 9 inch touch screen, easy-to-use and intuitive arrangement, similar to the latest generations of smart-phones or tablets.

The New Datatronic 5 and Massey Ferguson's Technology Package is a key asset for enhancing Precision Farming. Making agriculture more profitable and sustainable for the New Generation of Farmers.



4

**ISOBUS for total implement control** – ISOBUS allows an implement manufacturer's control system to be displayed on the terminal screen, saving owners and operators time and money, with no need to install additional monitors in the cab. Simply plug the implement lead into the tractor's ISOBUS socket and the system automatically uploads the operating menus and displays on the screen. MF 8700 S ISOBUS applies to the AEF (Agricultural Industry Electronic Foundation) certification.



5

**ISOBUS MultiPad switch assignment.**

ISOBUS implements can be controlled directly using the MultiPad lever. Having all controls (tractor and implement) on the same lever is a lot more convenient than using additional displays and levers. This really versatile system allows several implements to be stored to operate via MultiPad, so it can work with all ISOBUS implements currently in the farm fleet.



6

**Memorise data and settings** – Unlimited number of user settings configurations enable the system to record information during operation on area worked, fuel use, hours worked and much more. All the settings and parameters can be stored by the Datatronic terminal. Securely back-up those tractor settings: a truly unique feature of Datatronic terminal is the ability to save the memorised tractor settings. All these settings can be stored and recalled to find the previous setting that was used on a tractor. The operator can recall all its settings and be fully operational. All these settings can be transferred between all your machines equipped with Datatronic terminal.



# Guidance options to keep you on track for profit

Auto-Guide™ is Massey Ferguson's full featured, hands free steering system, available on new tractors or as an after-market installation. Auto-Guide™ is capable of delivering sub-metre, decimetre and centimetre accuracy, increasing the efficiency of your farming operations.



## Easy, fast set up with Go Mode function

Starts up within 5 minutes, even for first time users – This smart function allows the operator to begin working with auto-guidance/steering for the first time within a five-minute set-up time, making the system easy to work with and the benefits faster to reap.

This unique function allows Auto-Guide™ start-up within 5 minutes to allow even inexperienced drivers to step seamlessly into working with the system after just a few implement and wayline settings.

Implement

Wayline

Go!



**Virtually eliminates overlaps** increasing field area covered per hour

Guidance systems are proven to **save up to 12% fuel** in field operations



More efficient working means **less tedium, stress and fatigue for the operator** and more time to optimise performance of the machine



# You choose the level of accuracy you need to fit your requirements

## Submetre Accuracy

TERRASTAR L, EGNOS, WAAS, Autonomous, RangePoint RTX.

## Decimetre Accuracy

TERRASTAR C, CenterPoint RTX Standard.

## Centimetre Accuracy

Ntrip (3G), Satel UHF 400 Mhz (Option), CenterPoint RTX FAST US and EU (Satellite), Hiper AG with, Local solution.



# You choose your receiver according to the accuracy you are looking for

With the new Massey Ferguson Auto-Guide™, there are now two different receiver systems available, NovAtel® and Trimble®. Existing Trimble® RTK infrastructures on the farm, such as NTRIP, can continue to be used. A number of correction signals are supported, depending on the receiver, for example, EGNOS/WAAS or RangePoint RTX™, CenterPoint RTX™ and Ntrip. Talk to your local Massey Ferguson Dealer or Distributor to find out more.

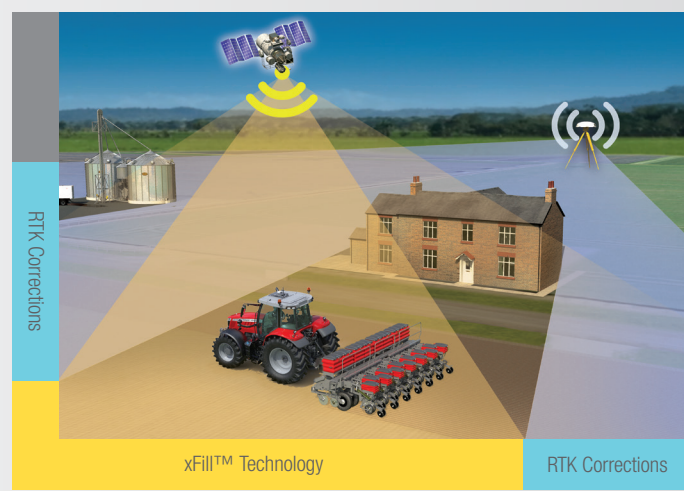

Should you lose your signal due to the terrain, Auto-Guide™ continues to work reliably up to 20 minutes without a correction signal thanks to Trimble®-xFill™ technology.



# AGCONTROL™

AgControl™ is the new Precision Farming solution from Massey Ferguson providing with the most advanced and most efficient Section Control feature. With the fully automatic Section Control for ISOBUS implements, operators can apply seeds, fertilizer or pesticides without overlapping. This prevents double treatment and areas worked outside of the field edges. With the aid of the straightforward and easy to use Section Control assistant, the operators can set the correction values for each implement, quickly and easily. The system uses the tractor's GPS system to automatically turn on and off individual sections in areas that have already been covered which automatically results in economical application and enhanced yields.

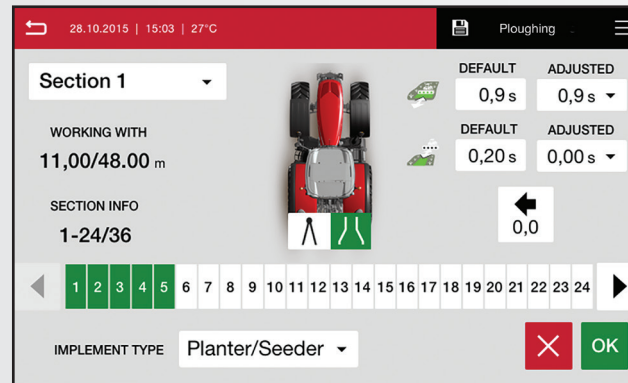

Machine Management



Machine Control

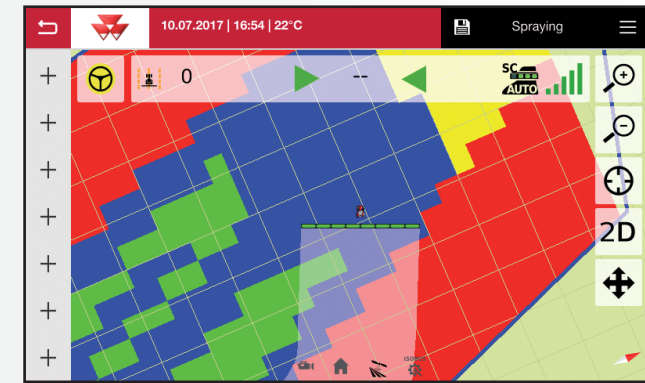

## Variable application with Variable Rate Control (VRC)

Data transfer with TaskDoc™ Pro now permits variable rate application, based on the needs of the soil or plants, and therefore saves operating inputs. The individual requirements for seeds, fertiliser and pesticides are shown on application maps. They are then called up during operation and automatically executed. The big advantage: operating inputs can be defined and planned with the aid of the field database and then applied with utmost precision. For example, you can tailor chemical or fertiliser application in areas as required, lowering input cost and further enhancing yields.





# TASKDOC™

Information is power, with accurate data measurement and recording enabling more precision in decision making. The pace of progress and innovation set by the MF 8700 S series is evident in the on-board technology solutions that it incorporates.

The new TaskDoc™ system have a real place in the future of agriculture, helping farmers to become more productive through the knowledge brought by putting precision-measured data at the business owner's fingertips.

With **TaskDoc™** all jobs' data can be recorded with a minimum of effort, documented in the field record and then analysed, all in the shortest amount of time. The data is transferred wirelessly from the Datatronic 5 terminal to the office using the ISOBUS standard TC-BAS. Data on the quantity of seeds and fertiliser applied or the fuel consumption is available immediately after the work is done.

The **TaskDoc™ Pro version**, also enables recording of the GPS position data and data transfer in real-time. This makes automatic, seamless exchange with ISOXML-capable field management software and mapping possible. The data for the operating inputs that have been used are transferred and can also be monitored through the Datatronic 5 terminal while working.

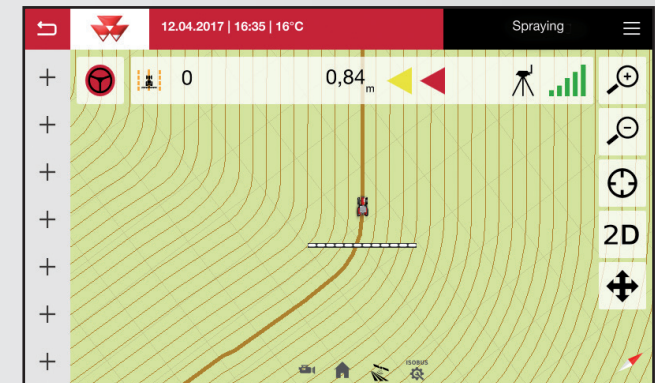
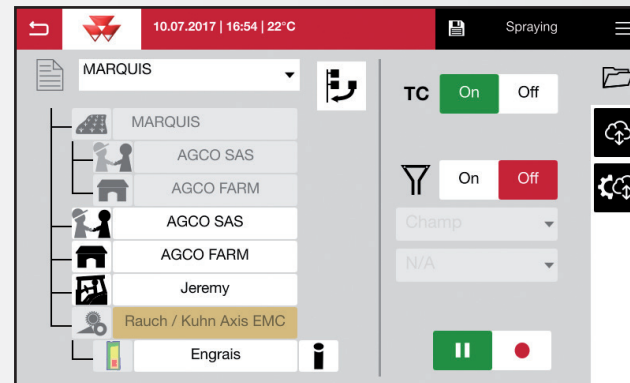



## Greater uptime, optimized maintenance and smarter services with Massey Ferguson Connected Services & AgCommand®



Connected technologies offered by the new AgCommand® website enable your Massey Ferguson Dealer to help you manage your equipment to maximize uptime and productivity, while reducing operating costs. That leaves you totally free to focus on improving your farm business.

MF Connected Services is a collection of intuitive technology features and best-in-class dealer support that make your life as an MF Customer easy, more profitable and efficient: from remembering to book a due service interval, to planning preventative maintenance to avoid any downtime when you need the job done, to monitoring your machine and fleet performance.

**With Massey Ferguson Connected Services, AgCommand® and your MF Dealer, you can rest assured you are in good hands.**

Through on-board sensors and GPS location, up to 25 can parameters can be collected via the AM-53 module, depending on your contract subscription, of your MF 8700 S and are transferred to a central and secured MF server, from where it can be accessed over the internet from any web browser on your farm computer, your tablet or your smartphone. If you allow, your local MF Dealer can access and evaluate this data, and so effectively provide you with the accurate support for :

# AGCOMMAND®

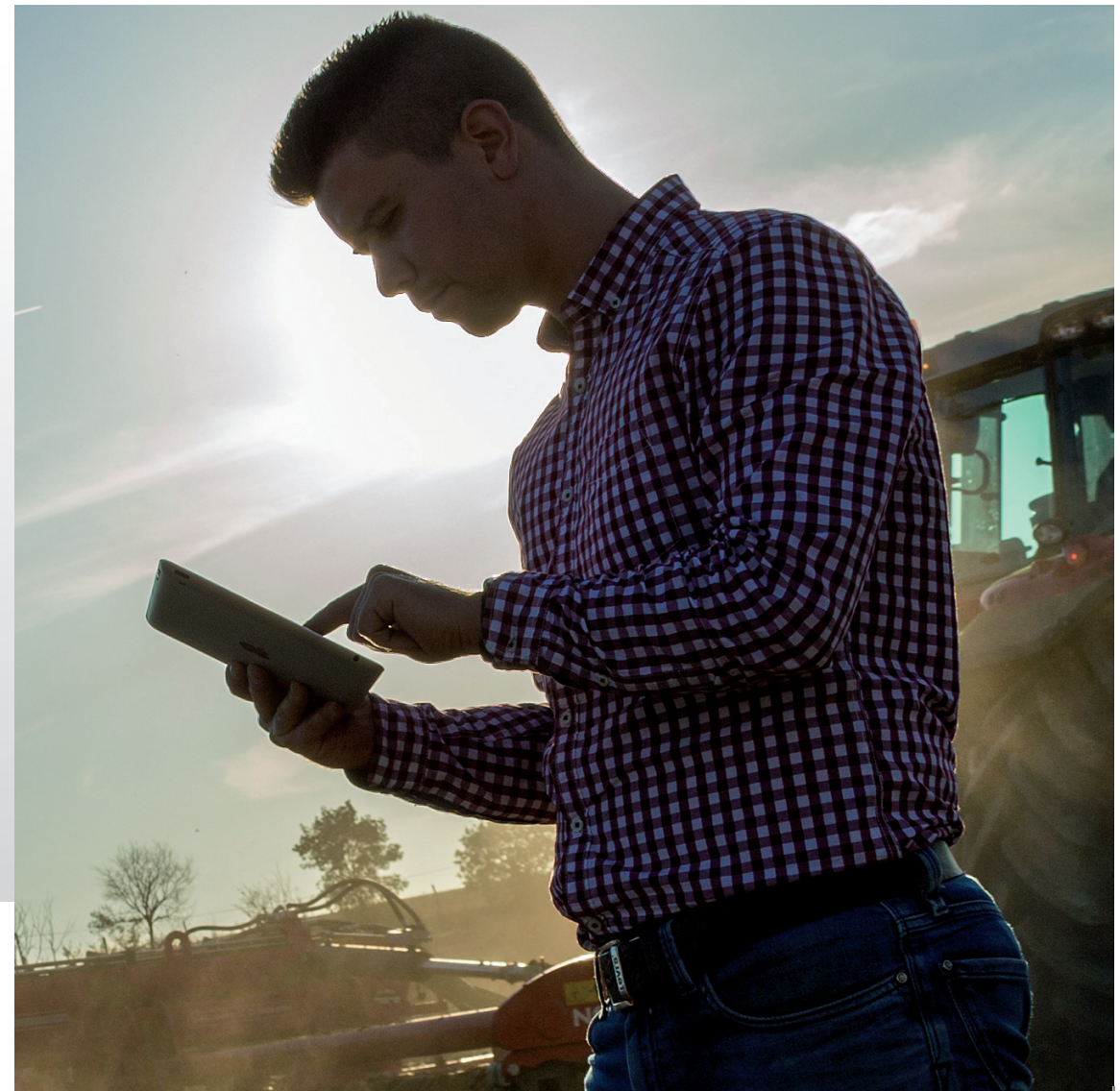





## Greater Uptime

Machine service and maintenance alerts so that you and your dealer can effectively prepare for your tractor's visit to the workshop, before contacting you to make an appointment. Having to remember when your MF service is due becomes a thing of the past.

ACTIVITY	MAINTENANCE	LOCATION
<p>SEVERITY: CRITICAL</p> <p>SEVERITY: CRITICAL</p>	<p>Massey Ferguson - MF 8735</p> <p>MF 8735</p> <p>Level 1</p>	<p>1,000 hrs</p> <p>Working</p> <p>ATIS Dealer MF</p> <p>AGCO International GmbH</p>
<p>SEVERITY: CRITICAL</p> <p>SEVERITY: CRITICAL</p>	<p>Massey Ferguson - MF 8732</p> <p>MF 8732</p> <p>Level 2</p>	<p>1,700 hrs</p> <p>Stopped/Idle</p> <p>ATIS Dealer MF</p> <p>AGCO International GmbH</p>
<p>SEVERITY: CRITICAL</p> <p>SEVERITY: CRITICAL</p>	<p>Massey Ferguson - MF 8737</p> <p>MF 8737</p> <p>Level 1</p>	<p>1,600 hrs</p> <p>Working</p> <p>UK Demo Fleet</p> <p>AGCO International GmbH</p>
<p>SEVERITY: CRITICAL</p> <p>SEVERITY: CRITICAL</p>	<p>Massey Ferguson - 7718 Dyna 6</p> <p>MF 7718</p> <p>Level 3</p>	<p>50 hrs</p> <p>Working</p> <p>UK MF Demo Fleet</p> <p>AGCO International GmbH</p>
<p>SEVERITY: CRITICAL</p> <p>SEVERITY: CRITICAL</p>	<p>Massey Ferguson - MF 9135L</p> <p>MF 9135L</p> <p>Level 3</p>	<p>45 hrs</p> <p>Stopped/Idle</p> <p>UK MF Demo Fleet</p> <p>AGCO International GmbH</p>



## Optimized maintenance

Critical machine alerts such as high coolant temperature or engine oil pressure will allow preventative maintenance avoiding any potential breakdown and downtime. Real time monitoring of machine parameters and GPS location helps plan maintenance.

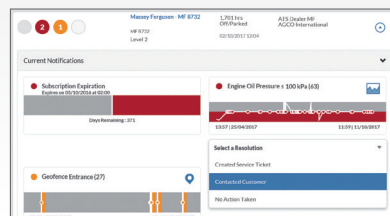

## Optimized Performance

Your dashboard provides you with full machine efficiency report to ensure you are getting the best return on investment. For example information on the fuel consumption and idle time monitoring can help drive down your costs.

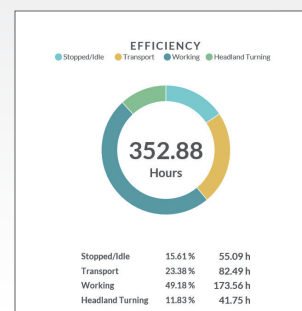

## Fleet monitoring and localization

With MF Connected Services you can easily monitor your fleet, know where your machines are, and their live performance in the fields. Thanks to the geofencing feature you can also receive alerts when your machine is leaving a predefined area. It can also, for example, send a message to alert you when an operator is returning to the farm or if he requires fuel in the field.

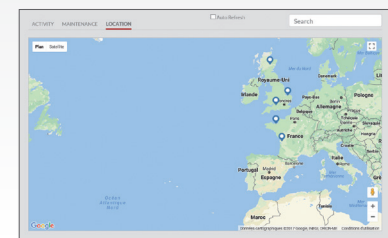

## Offered as an option, the MF Connected Services from AgCommand® allows you to choose:

**1.** The level of information you want to monitor from the basic to the more advanced solution

**2.** The number of hours of work and years you want to cover with your AgCommand™ subscription

**3.** Data accessibility to your local MF Dealer to benefit from their full support and only have to focus on your farm business

Please visit your MF local Dealer should you need more information.



## The new touch of traction and pulling capacity with light footprint on the soil.....

Tractor power means nothing if it cannot be transferred to where it matters: the ground. While we have developed one of the highest powered conventional tractors on the market, we've also put a great deal of research into ensuring that power is usable.

With a minimum weight of just 10.8t, the MF 8700 S Series tractors are up to 4t lighter than others in this class. This allows them to tread lightly for top work and transport, while the strong design also enables them to carry heavy loads or be ballasted up for draft operations.

A wide range of ballast and tyre choices, including a large rear wheel diameter of 2.15m, ensures that MF 8700 S tractors can be tailored precisely to the tasks that are expected of them, for maximum traction with the minimum of soil damage, whilst using the minimum of fuel. That is part of our commitment to help protect the soil and preserve the land for future generations.





# Highlights

Increased traction and low soil compaction can be achieved working with the right ballast and tyre choice including tyre pressure.

The right balance between ballasts and tyre choices brings:

- More power to the ground.
- Ultimate traction capabilities.
- Limited soil compaction to boost yields whilst maintaining soil health for the next generation.
- Improved fuel economy.



The latest tyre equipment allows MF 8700 S models to work at very low tyre pressures, even for high traction jobs, including dual wheels:

- Rear tyre choice up to 900 mm and 2.15 m diameter.

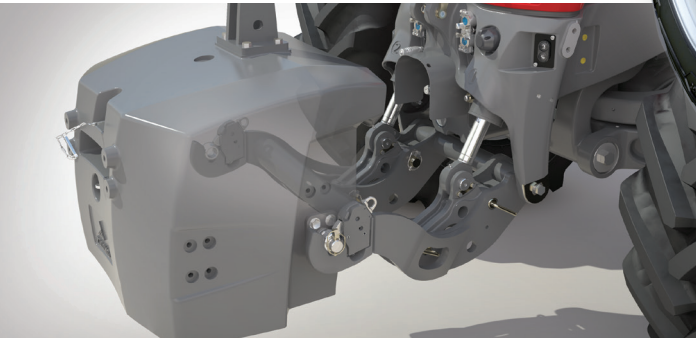

### A wide choice of ballasts are available

Sometimes you need extra weight to deal with intensive traction work. The MF 8700 S is available from factory or via AGCO Parts with additional front, rear and tyre weights to exactly match your needs. This offer includes a new design of 1500 kg and 2300 kg compatible with weight extension, wheel weight installation from 250 to 750 kg on each side and integrated belly weight from factory.



## Large footprint for maximum traction with Michelin tyre AXIOBIB2 High Traction tyre option





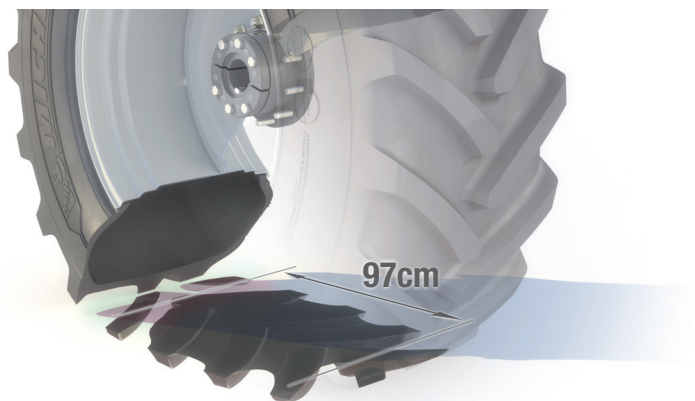

No machine works in isolation on a farm, so working closely with tyre and farm equipment manufacturers makes sense and helps us all to develop our technology. The results of our joint tests show how each element enhances the work quality, productivity and performance as well as protects the soil. It also illustrates how by carefully selecting the right tractor, equipped with the best tyres for the job and matching those to the best implement makes a big difference.

Massey Ferguson offers a wide range of tire options to match any transport or field applications. The latest tyre equipment allows MF 8700 S models to work at very low tyre pressures, even for high traction jobs, including dual wheels with rear tyre choice up to 900 mm and 2.15 m diameter for better power transfer to the ground.

Test results with an MF 8730 S fitted with Michelin AXIOBIB2 High Traction tire versus Michelin AXIOBIB first generation with a Gregoire Besson plough.

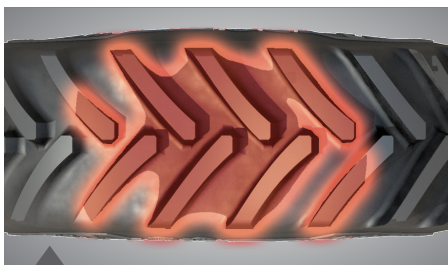
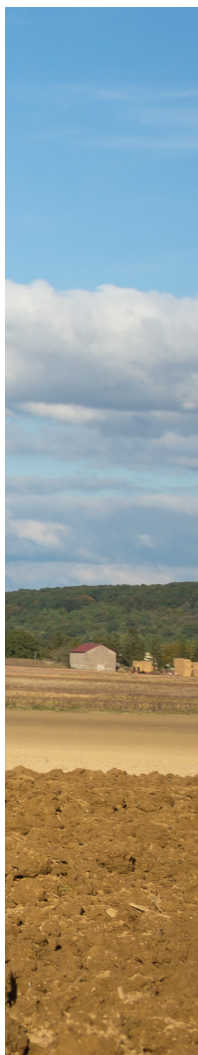

650/85R38  
2 pairs of lugs  
Smaller contact point, weight is distributed unevenly resulting in more compaction.

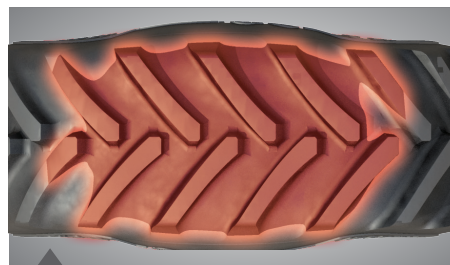

VF650/85R42  
More lugs to the ground - 3 pairs of lugs  
Larger footprint helps to spread weight more evenly, minimising soil compaction and maximising traction.

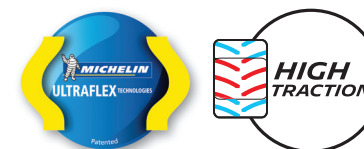

**+28%** More traction capacity, up to +28%

**+26%** Footprint length for lowest compaction

**+11%** Productivity - Outstanding level of traction to enable farmer to work faster in the field

**-10%** Less Fuel Consumption - Reducing farmers operating cost through fuel saving by up to -10%

**+4%** Low pressure level for preserving the soil and reduction compaction - VF MICHELIN Ultraflex technology for up to +4% crop yield



## Best in class 400hp manoeuvrability... with high payload !



Compact, manoeuvrable, with industry-leading power-to-weight ratio. MF 8700 S tractors handle easily and comfortably in the field and on the road, at minimum speeds and full speed. Its unique lightweight and high horse power design provides the MF 8700 S with the highest payload in this tractor segment in the market. Excellent manoeuvrability and stability when making headland turns or working in hilly fields, plus the ability to tread lightly yet pull strongly, is all part of our commitment to help protect the soil and preserve the land.



Curved chassis and integrated front linkage smart designs provide excellent manoeuvrability and tight turning angles.



Smart and easy system to pass from front linkage working position to stowage position for minimizing overall tractor length when front linkage isn't needed such as transport application.







#### Four-wheel drive and differential lock

The transmission controller also relieves the driver of many repetitive tasks of four-wheel drive and differential lock operation. It engages the differential lock when it's required, when the implement is lowered into work, and disengages it when it's not:

- Automatic disengagement of 4WD and differential lock above 14 km/h.
- Automatic differential lock disengagement when a rear linkage mounted implement is raised (and re-engagement when lowered).
- Automatic differential lock disengagement when either one or both of the brake pedals are pressed (and re-engagement when released).
- Automatic 4WD engagement when both brake pedals are depressed, when the differential lock is engaged or the handbrake applied.
- Automatic differential lock and 4 WD disengagement linked to wheels turning angle.

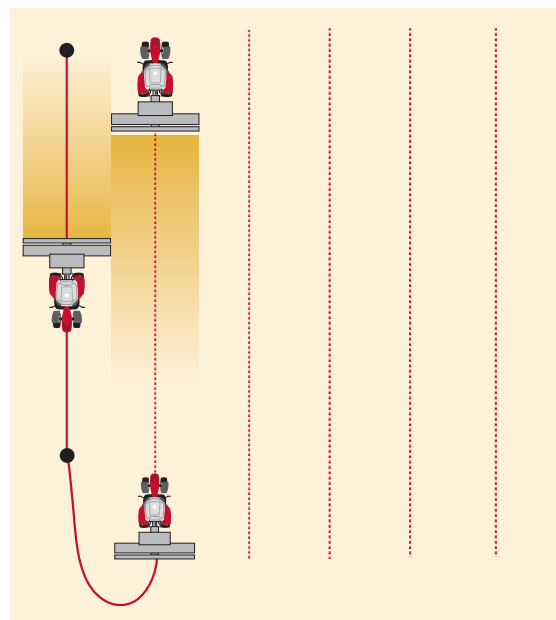

#### SpeedSteer – for precision and reduced effort

SpeedSteer allows the operator to adjust the steering ratio and select the number of steering wheel turns required for a given amount of steering angle. The system, which can be switched on and off, automatically disengages above 18km/h for safe operation at high speed, whether in the field or on the road (optional on Efficient version and standard on Exclusive).

#### QuadLink suspended front axle

Standard on all MF 8700 S tractors, QuadLink front suspension provides a smooth ride, improved traction, excellent ground clearance and tight turning angles, even on tractors with large tyres.

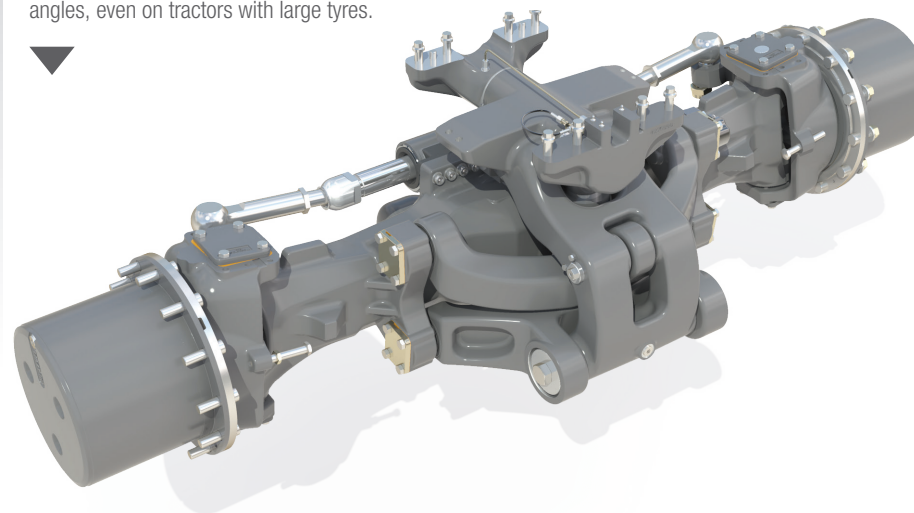

# Powerful Hydraulic Muscle:

## give a lift to your productivity

The innovator of three-point linkage power and hydraulic capability, Massey Ferguson has never rested on its laurels when it comes to ensuring its systems meet and exceed the requirements of modern machinery. Part of Massey Ferguson DNA, our three-point linkage is the finest example of productivity, power and responsiveness for the operator in the field for more than 75 years.

### Heavy-duty front and rear linkages

With a rear linkage lift capacity of 12,000 kg, there are few tractors in this power bracket that can match the MF 8700 S series for the ability to hoist heavy implements. The rear linkage design and the tractor's structural build are designed to handle such demands, with twin external lift rams and twin variable-float telescopic stabilisers. Quick couplers with decompressing system are standard, as are external linkage and valve controls. A total of 6 spool valves is available.

At the front, buyers can specify a fully-integrated 5,000 kg front linkage designed to match the Massey Ferguson front suspension, with two double-acting spool valves and a free return line.

### Rear Hitch

The rear hitch with a choice of pintle pin, pick-up hitch, clevis, K80 ball or drawbar has been completely redesigned to make coupling quicker, easier and safer. The ISO hitch design is compatible with a wide range of clevis and drawbar alternatives according to markets.

### The ultimate in draft control accuracy

Massey Ferguson continue to lead the way in electronic linkage control (ELC). On MF 8700 S tractors, the latest evolution in this development provides even greater accuracy in depth setting and ground contour following to provide excellent weight transfer, traction and workrates, while reducing wheelslip, tyre wear and fuel consumption. Armrest-mounted controls for functions including quick engagement, sensitivity and raise/drop speed fall intuitively to hand. There are also full rear fender controls on both sides of the tractor to help when hitching up.



### Powerful braking systems

As you would expect from a tractor of this size, designed to haul and handle the heaviest loads, the MF 8700 S braking system is as beefy as the rest of its hydraulic arrangement. Reassuring, fade-free braking comes courtesy of oil-immersed, power-assisted disc brakes, while air brakes for trailed equipment are an option.

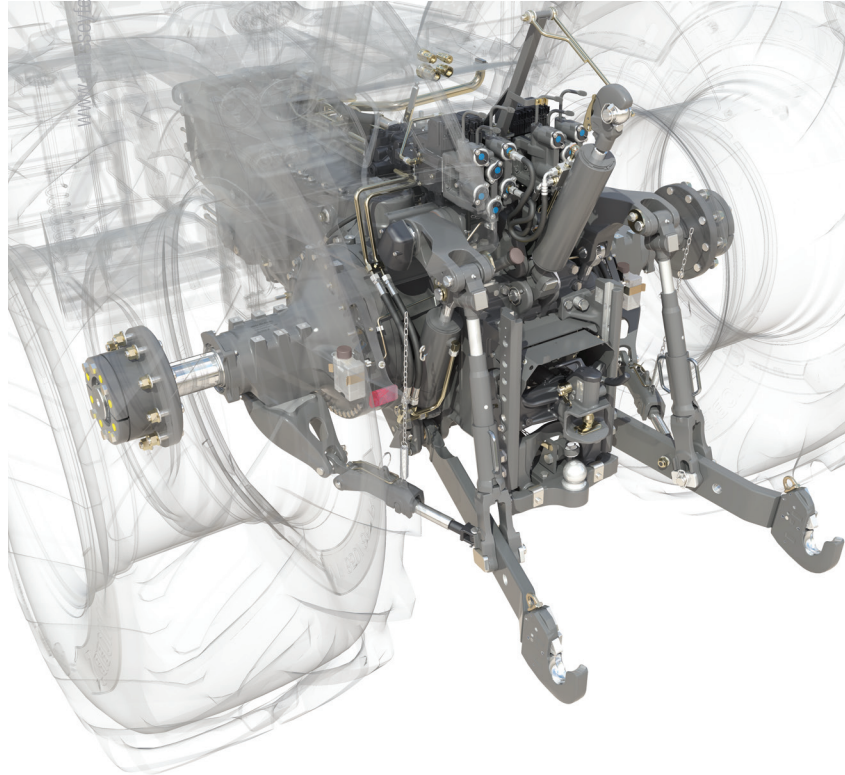



### Standard Active Transport Control

Designed to minimise the pitching action of heavy mounted equipment when in the raised position during transport or on the field headland, Active Transport Control, fitted as standard to MF 8700 S tractors, is a shock-absorbing system that is automatically adjusted for different implement weights to counter implement bounce. The result is smoother, safer, faster transport and a reduced risk of damage to the tractor and its hydraulic system.

### ATC and Quadlink

The combination of ATC and the Quadlink suspended front axle provides exceptional stability when transporting or operating mounted equipment at speed, resulting in greater comfort and safety for the driver, and ultimately greater productivity.

### Power Beyond

Built into the CCLS spool block is a Power Beyond facility that, via additional flow and return pipes, provides oil flow directly from the pump, enabling additional remote spool valves to be connected.

### Auxiliary spool valves

Standard specification comprises four electro-hydraulic spool valves, with up to eight available if required. Fingertip Spool Management allows complex equipment to be precisely and easily controlled. There are separate spools for the operation of the front linkage and front couplers, as well as the optional pick-up hitch.

### High flow, high pressure oil

All MF 8700 S tractors feature a closed centre load-sensing (CCLS) hydraulic system that provides 205 l/min of oil flow for both linkage and external services, for fast response whatever the load. The result: the ultimate in fuel and power efficiency. Decompression-type hydraulic couplers make implement attachment easier, allowing coupling and uncoupling under pressure.

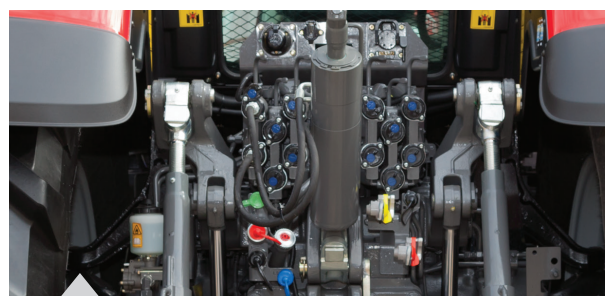

All rear couplers are equipped with an hydraulic decompressing system.





MF 8700 S



# Performing the most demanding operations with precision

## High specification PTO

MF 8700 S tractors can be specified with a fully-independent 540 Eco/1000 rpm PTO, or 1000/1000 Eco speeds. External engagement and emergency stop buttons provide convenience and safety. External engagement can be automated with engine speed for fast control of implement such as slurry tank filling.

## Economy PTO

Achieved at around 1,600 rpm, 540E and 1,000E rpm economy PTO speeds further improve fuel efficiency and noise levels when on lighter duties.

## Automated PTO control

In 'Auto' mode, the PTO is automatically disengaged when travelling at speeds above 25 km/h, while it is also disconnected when the linkage is raised and re-engaged when it is lowered. The transmission controller monitors and controls PTO engagement according to load for a smoother take-up, leading to improved driver comfort whilst protecting both tractor and implement from damage due to inappropriate engagement.

## Front PTO

A six-spline front PTO which operates at 1,000 rpm is optional on MF 8700 S tractors, and when combined with a front linkage allows a wide range of additional implements to be powered, helping to reduce passes and improve efficiency.

## Power with economy

Nominal PTO speeds are achieved at, or near to, 1,950 rpm, which is also maximum engine power. With the benefit of a constant power band of up to 600 rpm and the ability, with Dyna-VT ability, to precisely select any ground speed at the chosen engine speed, you can always achieve a perfect match of PTO speed, forward speed and power, for optimum economy.

Command Centre PTO selector switches and Auto activation button.



Fender mounted PTO, hydraulic spool valve and linkage controls.



Pillar mounted PTO speed selection controls and linkage controls.



# MF 8700 S

## The new touch of quality and customer peace of mind



### Massey Ferguson faces the challenge of converting quality into a fundamental brand value.

Following years of human and financial investment, and a continuous drive to implement robust processes and rigorous controls, Massey Ferguson has reached its objective. Today, the quality of Massey Ferguson machines is increasingly recognized.

To ensure the reliability and quality of your MF 8700 S Series tractor and maximize your return on investment, the entire Massey Ferguson workforce implements strong, rigorous processes, and extending from design, purchasing, manufacturing all through to customer delivery and service at your local dealer or distributor.









The cab air filter can be removed easily for cleaning.



The AdBlue® tank has been carefully positioned to improve insulation in high and low temperatures. Filling of both tanks is safe and convenient.



The waisted bonnet and front axle design ensures comfortable access to the engine oil filters and oil dipstick.



Plenty of room to access radiators for cleaning.



The well proportioned cooling package is easy to access, clean and maintain. 90% of dust is removed naturally thanks to the suction from the cooling fan. The engine air filter is also very easy to access and clean.



## Servicing made easy

Right from the first drawing, the MF 8700 S has been designed to provide fast, straightforward, easy and cost-effective routine maintenance.

Servicing is straightforward and simple, taking the stress out of maintaining your tractor and leaving you with more time in the field/at work. With the self adjusting engine valve clearance, maintenance costs are substantially reduced.

With a Massey Ferguson MF 8700 S series tractor, time spent in the yard preparing for the day ahead is kept to a minimum. We have combined practicality with style to ensure daily maintenance is speedy, straightforward and simple, taking the stress out of maintaining your tractor, getting you to the field earlier for greater productivity.



The single piece bonnet lifts fully to allow excellent access for full servicing.



# MFservices

Combined services to increase our customers' profit and efficiency

Welcome to MF Services – everything you need to support the operation of your Massey Ferguson machine.

Accessible and adaptable, MF Services will help you control running costs, budgeting and business planning - ensuring each machine operating hour is a success and giving you the freedom to focus fully on the core business of farming.

This comprehensive suite of service-related-products makes it easier than ever to own and operate MF farm equipment.

Covering finance, extended warranties and servicing, telematics, precision farming technologies and genuine parts, MF Services is your one-stop shop for all existing and future services to keep your business on track and your equipment up and running.

Our goal is to ensure that your Massey Ferguson machinery is operationally-efficient at the highest level throughout its working life.

## MF*Care* provides total peace of mind

MF*Care* is a comprehensive, industry-leading package that provides total care of your MF 8700 S tractor providing routine maintenance, repairs and a full AGCO-backed warranty, which includes:

- Engine and transmission
- Electronics
- Hydraulics
- Cab and controls
- PTO
- Axles
- Steering

Regular servicing in the MF*Care* plan provides 'preventive maintenance' – picking up any faults before they become a problem, which helps reduce downtime. A full dealer service history, using genuine AGCO Parts will also increase the residual value of the machine.

## AGCO Finance\* provides the perfect financing arrangement for your business

AGCO Finance is the integrated financial services arm of Massey Ferguson offering tailor made solution to your own farm, which includes :

- Leasing
- Loan facilities
- Hire purchase
- Full service packages
- Contract hire

\* Please contact your Massey Ferguson local dealer to check availability in your area. Terms and conditions apply that might vary according the market or country.



Industry-leading parts supply from AGCO Parts.





# No hidden costs:

## All-Inclusive from Massey Ferguson – a new generation of full service\*

Massey Ferguson is the only brand which can offer you a full service package for your new MF 8700 S tractor including:

**YOUR TRACTOR +**

**YOUR FINANCING +**

**YOUR REPAIR AND  
MAINTENANCE MANAGER CONTRACT**

For your individual quotation, contact your local MF dealer!

So you'll know exactly your cost of ownership with no hidden agenda, no extra expenses for up to 5 years and 6000 hours in the UK and Ireland.

**At the end of the contract, the choice will be yours:**

1. Get another brand new Massey Ferguson tractor so you are sure you are using the latest onboard technologies.
2. Return the tractor to your local MF Dealer!

This is specially designed to meet the needs of UK and Irish farmers. This scheme insures you will benefit from superior innovation in the machinery industry that will secure your profitability. Similar offers are available in France and Germany.

**In summary you will:**

- Know the cost of ownership from day 1:  
Ensuring it is easy to budget and there are no surprises.
- Benefit from the very latest technology on your tractor.

Don't hesitate to discuss with your local Massey Ferguson dealer or your AGCO Finance specialist. They will be able to provide you with a tailored solution to help grow your business.

\* only applicable on MF 8700 S Series and only available in UK & Ireland, France and Germany. Please contact your AGCO Finance specialist and your local dealer to check availability in your area. Terms and conditions apply that might vary according to the market.



# WANT TO KNOW THE COST PER HOUR OF THIS MF 8740 S DYNA-VT?





# Standard and optional equipment – tailor your tractor to you

	Efficient	Exclusive
<b>Engine</b>		
6 cylinder AGCO POWER Stage 4	●	●
Selective Catalytic Reduction (SCR) technology	●	●
EEM Engine with memorised speed control	●	●
Engine Block Heater	○	○
<b>Transmission</b>		
Power Control shuttle	●	●
T lever on Command Control Armrest	●	–
MultiPad lever on Command Control Armrest	○	●
Dyna-VT 50km/h* Eco with Dynamic Tractor Management (DTM) @ 15 T gross vehicle weight	●	●
Dyna-VT 40km/h Super Eco with Dynamic Tractor Management (DTM) @ 18 T gross vehicle weight	○	○
Cruise speed control	●	●
ParkLock	●	●
<b>Operator environment</b>		
Standard Air Conditioning	●	–
Automatic Air Conditioning	○	●
Super Deluxe Air Suspended Dynamic Damping System Seat	○	–
Super Deluxe Air Suspended Maximo Evolution Seat	●	●
Leather Super Deluxe Air Suspended Maximo Evolution Seat, leather auxiliary seat & leather steering wheel	○	○
Auxiliary Seat with Seatbelt	●	●
Radio - MP3 - SD card slot - USB	●	–
Radio, CD, MP3, Bluetooth connexion, USB & Front auxiliary	○	●
Telescopic double angle mirror	●	–
Telescopic double angle mirror with Electric Adjustment and de-icing	○	●
Active mechanical Cab Suspension	○	●
<b>Technology</b>		
9" / 23cm Datatronic 5 touch screen	●	●
Trailer steering axle management ready	●	●
Dual Control	●	●
Radar and slip control	●	●
Headland Management System	●	●
ISO 11786 signal connector	●	●
ISOBUS capability & connector	●	●
MultiPad with Isobus implement control switch assignment	○	●



	Efficient	Exclusive
AgControl™ 24 section control	○	○
AgControl™ 24 sections control with 2 VRC	○	○
SpeedSteer	○	●
Auto-Guide™ Ready	○	○
Auto-Guide™ Novatel - Submeter	○	●
Auto-Guide™ - TRIMBLE - Submeter	○	○
Auto-Guide™ - Novatel - Centimetre	○	○
Auto-Guide™ - Trimble - Centimetre	○	○
AgCommand®	○	●
<b>Chassis and hydraulics</b>		
Electrical controls of spool valves	●	●
Electronic Joystick	●	●
Power beyond with couplers	○	●
Electronic linkage controls with Active Transport Control	●	●
Auto PTO function	●	●
Auto 4-Wheel-Drive and Auto DiffLock functions	●	●
Telescopic stabilisers	●	–
Automatic stabilisers	○	●
Hydraulic Toplink	○	○
Integrated front linkage system	○	●
Integrated Front PTO	○	○
<b>Electrical equipment</b>		
Automatic Isolator switch	●	●
External lift control on fenders	●	●
External PTO start/stop control on fender	●	●
External remote valve control on fender	●	●
LED working lighting	○	○
<b>Other equipment (specifications may vary by market)</b>		
Quadlink – Suspended front axle	●	●
Pivoting front fenders	●	●
Additional heater in cab	○	○
Pneumatic trailer brake	●	●
Pneumatic and hydraulic trailer brake	○	○

**KEY**  
 – Not available  
 ● Standard specification  
 ○ Optional  
 \* Depending on market legislation



# Specifications as standard

	MF 8727 S	MF 8730 S	MF 8732 S	MF 8735 S	MF 8737 S	MF 8740 S	
<b>Engine</b>							
Engine Type	AGCO POWER						
No. of cylinders/no. of valves/Capacity	No /no./l 6 / 4 / 8.4						
Bore / Stroke	mm 111 / 145						
Aspiration	2 stage Turbocharger with Interstage Charge Air Cooler and electrical wastegate at the high boost pressure side						
Injection type	Common rail						
Fan type	Vistronic – variable fan speed						
Maximum hp @ 1,950 rpm	⊕ ISO hp	270	295	320	350	370	400
Maximum torque @ 1,500 rpm	⊕ Nm	1,220	1,300	1,390	1,530	1,540	1,540
Maximum power with EPM	⊕ ISO hp	300	325	350	380	400	405
Maximum torque with EPM	⊕ Nm	1,300	1,390	1,500	1,590	1,600	1,600
Max. power available @ PTO shaft (OECD, accuracy +/- 3%)	hp	225	250	275	300	320	355
Fuel tank capacity	litres 630						
AdBlue® tank capacity	litres 60						
Service interval	hours 500						
<b>Transmission Dyna-VT</b>							
Type	Stepless, Continuously variable transmission with Dynamic Tractor Management (DTM)						
Field speed range	km/h	0,03 - 28 km/h Forward and 0,03 - 16 km/h Reverse					
Road speed range	km/h	0,03 - 50 km/h* Forward and 0,03 - 38 km/h Reverse 40 km/h Eco at 1400rpm - 50km/h* Eco at 1550rpm					
<b>Rear Linkage and hydraulics</b>							
Lower links type	Category	3 or 4					
Maximum lift capacity, at link end	kg	12,000					
Hydraulic type	Closed Centre Load Sensing						
Maximum Flow	litres/minute	205					
Maximum pressure	Bars	200					
Maximum no of rear spool valves	6						
<b>Front linkage and Front Power Take-Off</b>							
Type	Integrated on chassis with independent valve control, electro-hydraulic control						
Lower links type	Category	3					



Front linkage and Front Power Take-Off (cont.)	MF 8727 S	MF 8730 S	MF 8732 S	MF 8735 S	MF 8737 S	MF 8740 S
Maximum lift capacity, at link end	kg					
Maximum no of front spool valves	2					
Engine speed at 1000 front PTO speed	rpm					
<b>Power Take-Off (Rear)</b>						
Operation and control	Electro-hydraulic engaged. Start/stop control on armrest and on rear fender, with headland automation					
Speed selection	Electro-hydraulic control in cab					
Engine speed at 540Eco / 1000	rpm					
Engine speed at 1000 / 1000Eco	rpm					
Shaft diameter	inches					
<b>Wheels and Tyres (Full range available. Please consult your Dealer)</b>						
Front	620/75R30 620/75R30 600/65R34 650/60R34					
Rear	650/85R42 710/85R38 710/75R42 900/60R42					
<b>Weights</b>						
Average minimum weight with no ballast	kg					
Maximum gross vehicle weight	kg					

**KEY**

- ✦ ISO TR14396
- Not available
- \* Depending on market legislation

	MF 8700 S
A – Wheelbase – m	3.1
B – Overall length from front weight frame to rear linkage arms – mm	5,552
B – Overall length from front linkage to rear linkage arms – mm	6,200
C – Height at centre of rear axle to top of cab – mm	2,353
D – Maximum height – mm	3,515

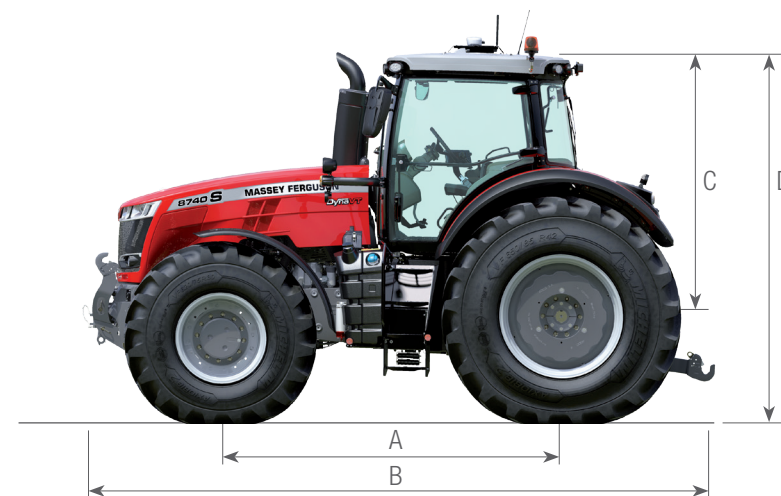
**Dimensions**



# MASSEY FERGUSON

**A world of experience. Working with you.**



Web: [www.MasseyFerguson.com](http://www.MasseyFerguson.com)

Facebook: [www.Facebook.com/MasseyFergusonGlobal](http://www.Facebook.com/MasseyFergusonGlobal)

Twitter: [Twitter.com/MF\\_EAME](http://Twitter.com/MF_EAME)

Instagram: [Instagram.com/MasseyFergusonGlobal](http://Instagram.com/MasseyFergusonGlobal)

YouTube: [www.YouTube.com/MasseyFergusonGlobal](http://www.YouTube.com/MasseyFergusonGlobal)

Blog: [Blog.MasseyFerguson.com](http://Blog.MasseyFerguson.com)



MASSEY FERGUSON® is a worldwide brand of AGCO.  
© AGCO Limited. 2017 | A-A-16460/1117 | English/0118/V2



Responsible forest management

